

LD34

High Power Linear In-ground LED Wall Grazer



Data sheet - Page 1



LD34 is a fixed 2.5° tilt, shallow recessed, low glare, in-ground linear wall grazer, which offers outstanding continuous wall washing capabilities. This IP67 rated, high power surface grazer, features an optional frosted diffusion filter to illuminate lower parts of the wall, with individual cowls over each LED ensuring low glare from the viewers perspective. Available in customised lengths up to 1.4m, with integral glare control options and a range of colour temperatures, including RGBW and Tunable white, the LD34 combines a compact minimal design with the latest in LED technology.

Key Features

- Superb wall grazing capabilities with a new 60° x 15° beam
- Compact design with only a 55mm recess depth required
- High power with up to 4100lm/m at 5000K
- Range of glare control options
- Individual LED cowls ensure low glare from all directions
- Optional frosted diffusion filter to illuminate lower parts of the wall
- First fix concrete housing available
- LED spacings of 50, 75 and 100mm
- Fixed 2.5° tilt
- Spacing is maintained across multiple lengths, ensuring no dark spots
- Lengths are customised to suit, to a maximum of 1.4 metres
- Available in Switched, 0-10V, DMX, DALI and Mains dimmable drivers

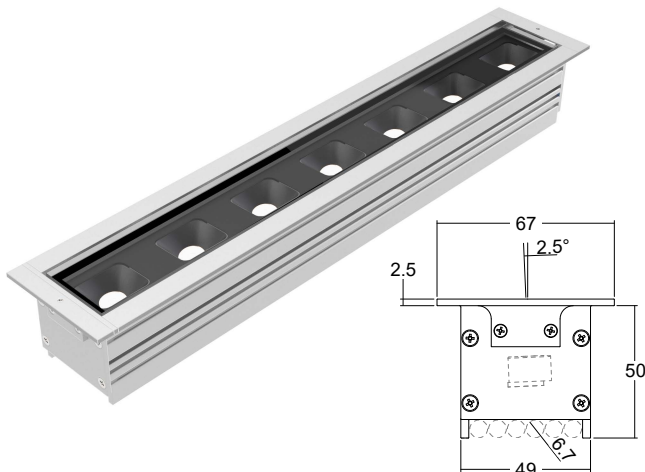

Specification

Applications				
Beam Angles	12°, 31°, 48°, 36° X 12°, 60° X 15°			
LED type	Cree XPG2			
Colour temperature	2700K / 3000K		5000K	
Drive Current (mA)	500	700	500	700
LED power per LED* (W)	1.7W	2.4W	1.7W	2.4W
CRI (typical)	93	93	75	75
Forward voltage (V) ₁₀₀	3.0V	3.2V	3.0V	3.2V
LED spacing	Delivered lm/m** (L ₁₀₀)			
50mm	2553	3380	3101	4107
75mm	1659	2197	2016	2670
100mm	1277	1690	1551	2054
Lumens per circuit watt	75	70	91	86
LED lifetime (to 70% lumen maintenance)	50,000hrs at a max ambient temperature of 35°C			
Materials	Silver or gun metal grey anodised aluminium body & end caps, polycarbonate cover and cowls, 8mm thick glass			
Wiring	Comes pre-wired with 2m lead, can be specified with up to 10m at extra cost			
IP rating	IP67			
IK rating	IK08			
Static load	1500kg			

*LED wattage includes losses associated with using an 85% efficient driver

**2700K lumen output is 12% lower than the 3000K figure listed

LD34

High Power Linear In-ground LED Wall Grazer



Data sheet - Page 2

Light Distribution and Glare Shield Options

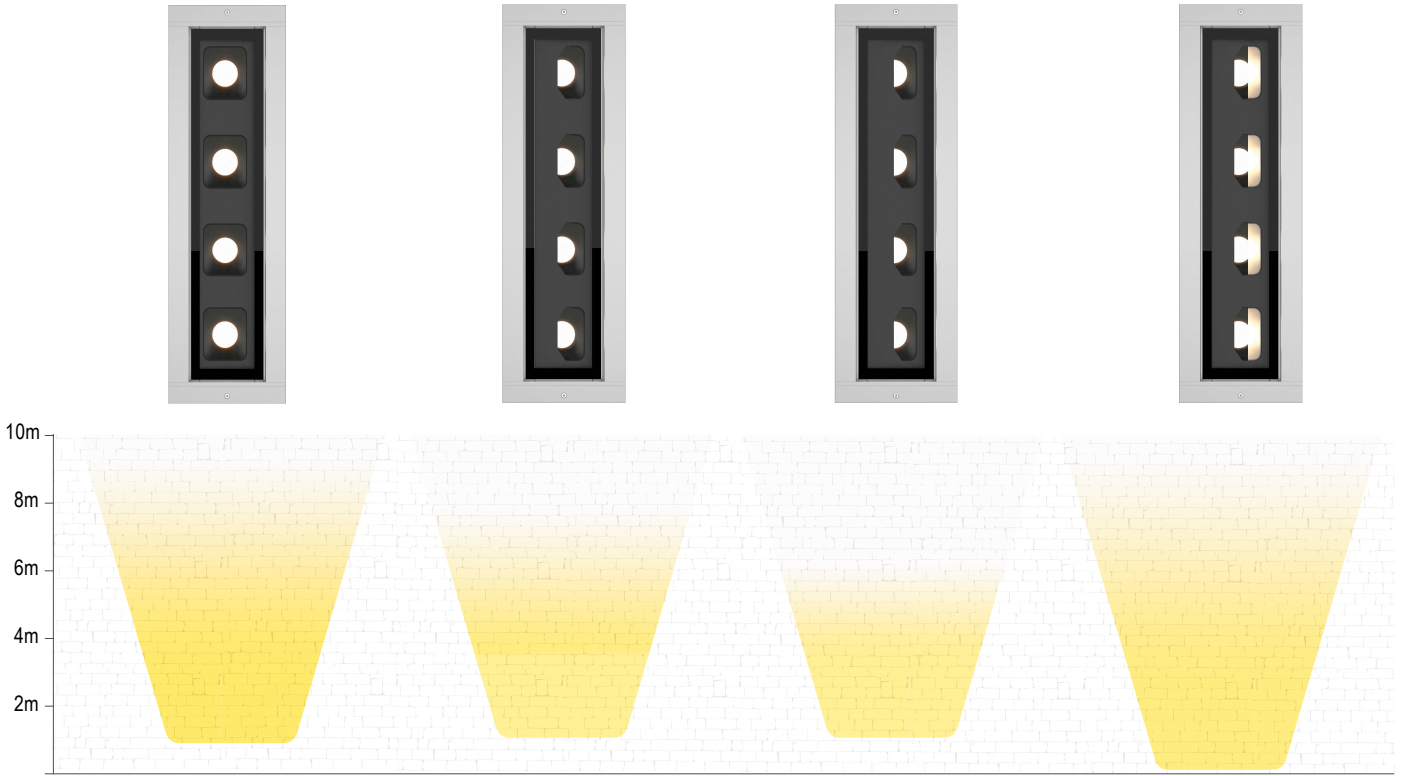

Please note this is a graphical guide to the expected light output, refer to the photometric files for more detailed data.

LD34

No glare shield for maximum lumen output. Deep recessed optic and matt black cowl aids in glare reduction.

/GS40

Teamed with the 2.5° fixed tilt the 40% glare shield provides glare protection without a significant reduction in output.

/GS50

Half glare shield. For an increased cut-off angle and greater glare control.

/GS40 with /FD

40% glare shield and diffusion film combination. The aperture allows the main punch of the beam to leave the fitting, providing glare protection from one side and moving the start of the beam down to the floor on the other.

Frosted Diffusion Film

/FD

This accessory is particularly useful when the LD34 needs to be placed further from the wall. It provides a smooth consistent beam that starts as close to the bottom of the lit surface as possible.

The frosted diffusion film can be specified with any of the glare shield options. However it is recommended to be used with the /GS40.

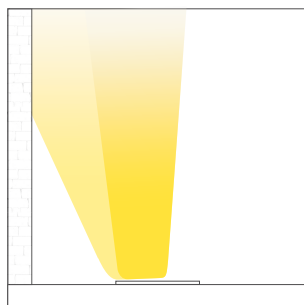

/GS40

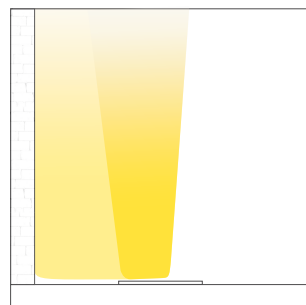

/GS40 with /FD

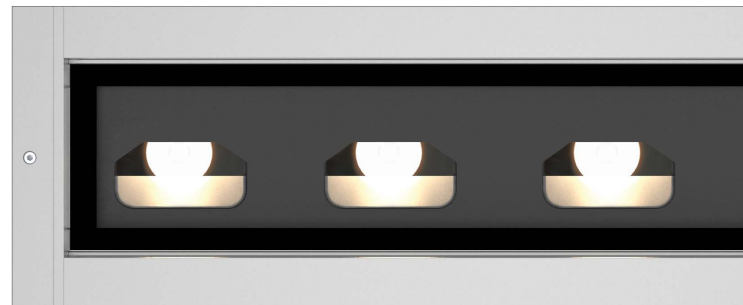



LD34

High Power Linear In-ground LED Wall Grazer

Data sheet - Page 3

Installation Guide

Below is a luminaire positioning guide. Every project and lighting scenario will be different; the table below is to be used as a starting point for any wall wash design. Please use our photometric files to further test the desired effect for your application. Files are available on our LD34 product page on the website.

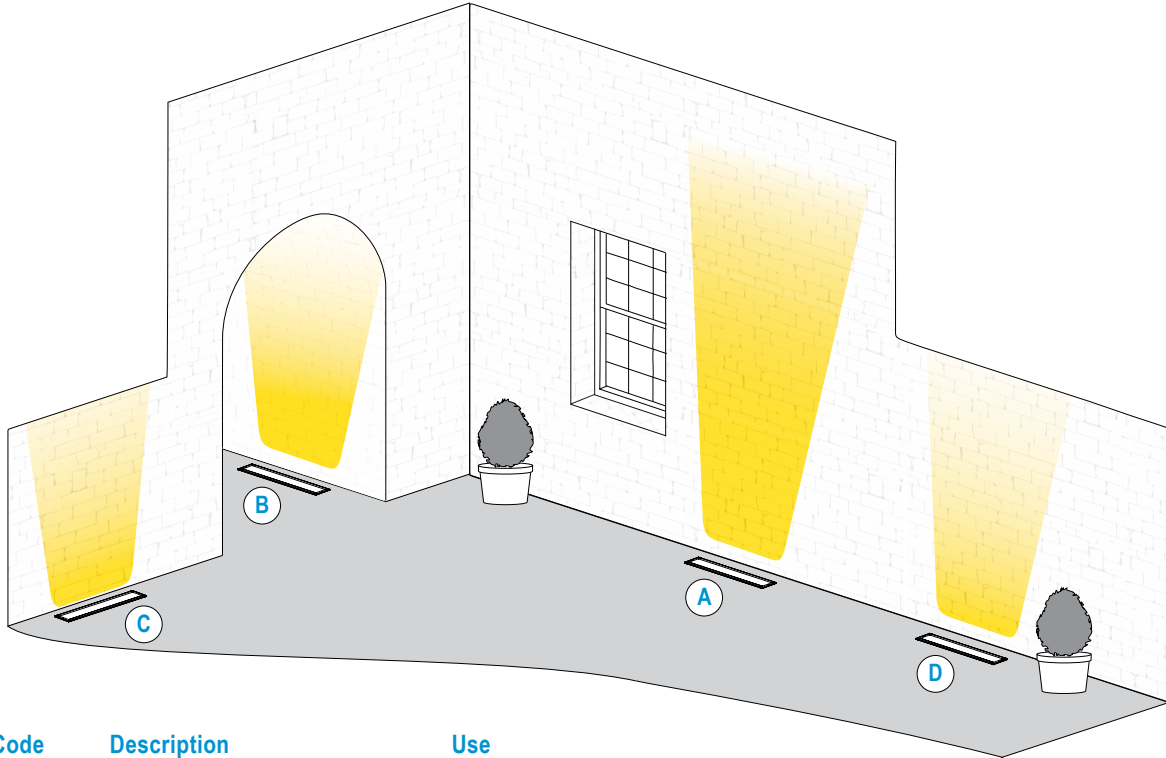

Option	Code	Description	Use
A	LD34	Standard LD34	The standard LD34 can be used when maximum output is required. This option achieves a throw of up to 20m. Even without the presence of a glare shield the cowls over each optic provide a good amount of glare control
B	/GS50	Glare shield with 50% optic coverage	This option has been designed for use when glare protection is the priority. Narrow corridors and walkways are ideal locations.
C	/GS40/FD	Glare shield with 40% optic coverage and linear diffusion strip.	This option has been designed to lower where the beam starts on the lit surface. This is useful for lighting low walls or when the fitting must be placed further from the lit surface.
D	/GS40	Glare shield with 40% optic coverage	Ideal for use in walkways and arches where glare protection is needed as well as a good punch up the wall

Beam Angle Options

/NB	/MB	/WB	/OB	/EOB
Narrow Beam 12°	Medium Beam 31°	Wide Beam 48°	Oval Beam 12° x 36°	Extra Oval Beam 15° x 60°



LD34

High Power Linear In-ground LED Wall Grazer

Data sheet - Page 4

Preliminary Product Spacing Guide

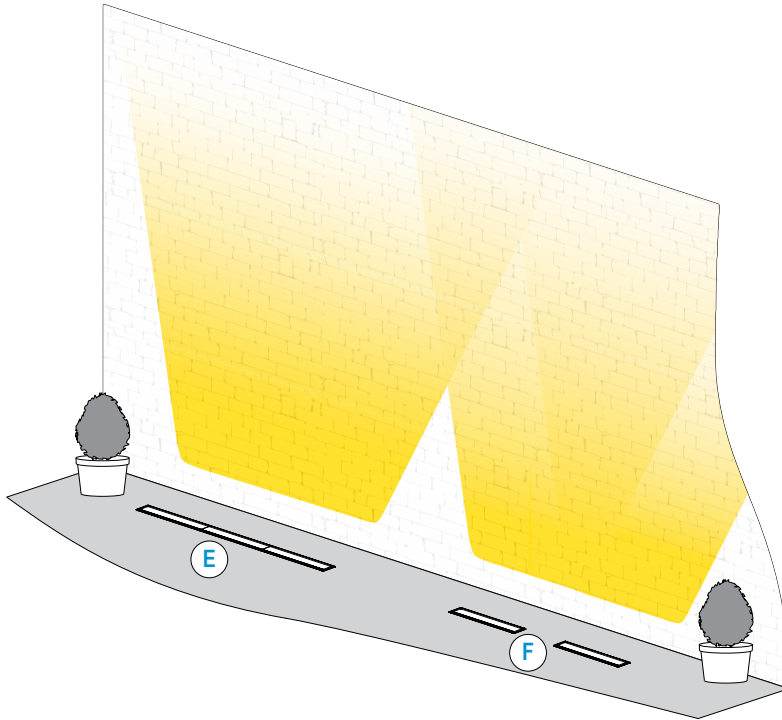

E

LD34 features the ability to create outstanding continuous wall washing capabilities, by seamlessly connecting multiple fittings while maintaining LED spacing.



F

LD34 can be supplied with a new optic, the /EOB. This 60° x 15° optic and film combination allows fittings to be spaced apart from each other but still produce a consistent lit effect.

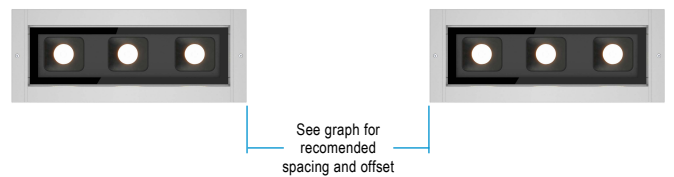

Custom Length Guide

The table below provides advisory module lengths to ensure drivers are used to there full potential. Custom module and link lengths can also be specified.

500mA		700mA	
LED spacing	Optimum fitting length	LED spacing	Optimum fitting length
50mm	1418mm (28 LEDs)	50mm	1318mm (26 LEDs)
75mm	1068mm (14 LEDs)	75mm	993mm (13 LEDs)
100mm	1418mm (14 LEDs)	100mm	1318mm (13 LEDs)

Please note an additional 9mm has been added at each end of the run to account for the end cap flange.

When spacing fittings apart, the use of /EOB and possibly /FD is recommended depending on offset and desired lit effect. The graph below shows recommended offsets and their corresponding spacings.

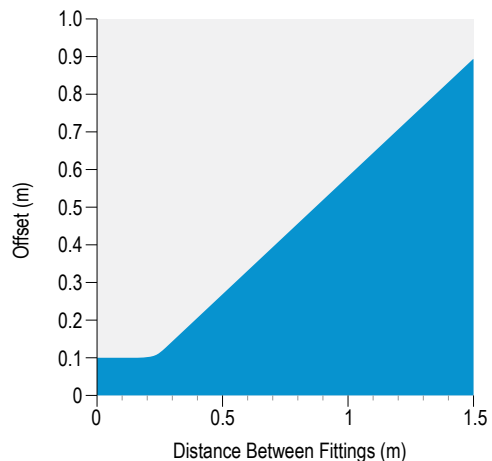

Note: These are estimated results please use photometric data to verify.

LD34

High Power Linear In-ground LED Wall Grazer



Data sheet - Page 5

Finishes

LD34 has been designed for extreme environments, so only high quality materials and finishes are used to ensure long lasting reliability. All parts are silver or gun metal grey anodised is to a minimum thickness of 25 microns which offers high protection in all external environments.

Silver Anodised

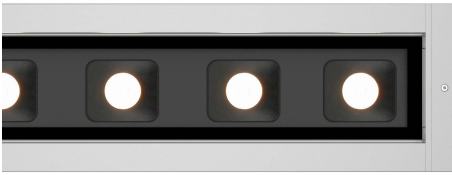

Gun Metal Grey

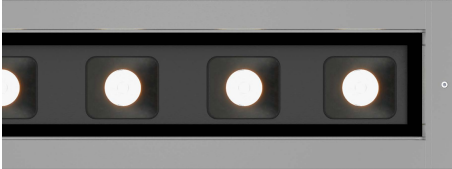

Accessories

/GL

Anti glare louvre. LD34 can be supplied with the glare louvre however the /GS40 is recommended as it provides the same amount of glare protection and delivers a better lit effect on the wall. Please note this is always supplied in a black finish, and is supplied as standard with the louvre positioned to reduce glare when looking at the lit surface.

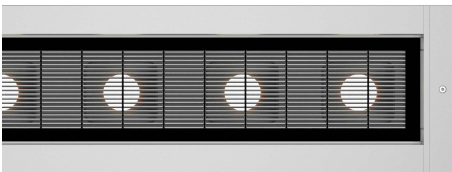

Fixing Options

/SC Spring Clips

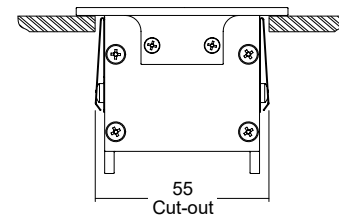
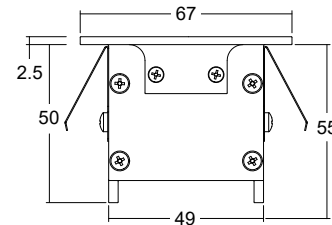

/CH Concrete Housing

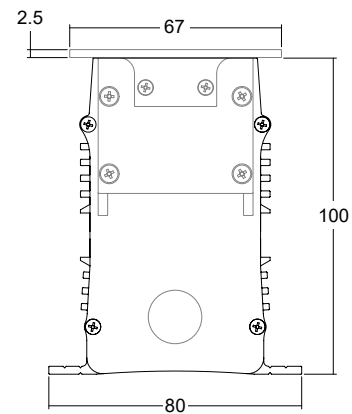

Similar Product

LD34 has been designed alongside LD38 to enable seamless integration of both products throughout a project. Please see the website for more details.



LD34

High Power Linear In-ground LED Wall Grazer



Data sheet - Page 6

Product Features

GLASS

8mm thick low iron glass.
Customisable lengths.
1500kg Static Load.
Walkover.

OPTIC COVER

Optic cover hides the
internal workings of the
product.

COWL

Directs light to where it's
needed and features a
low glare surface finish.

OPTIC

High efficiency optics with
a new range of beam
angles to create the ideal
lit effect.

EXTRUSION

High quality extrusion
and anodising available
in silver or gun metal
grey. Other finishes
available, please talk to
sales. Integrated 2.5°
tilt provides LD34 with
exceptional wall washing
capabilities.

FLANGE

Removable flange for
in-line lengths and single
units.

FROSTED DIFFUSION FILM

Optional accessory that can
be used to lower the start
of the beam to the base of
intended lit surface.

ACCESSORY

/SC - Spring clips

ACCESSORY

/CH - Concrete Housing

LD34



High Power Linear In-ground LED Wall Grazer

Data sheet - Page 7

Order Codes and Options

White LED Options - Linear Light Engine 

Product code	LED colour	LED spacing	Beam angle	Fitting colour	Fixing option	Accessory	Length
LD34- 500 - 700	<input type="text"/>	<input type="text"/>	<input type="text"/>	<input type="text"/>	<input type="text"/>	<input type="text"/>	<input type="text"/>

Example: LD34-700 / LW30 / 50 / OB / Silver / SC / GS40 / 500mm

Product codes with output options

1.7W LEDs at 500mA	LD34-500
2.4W LEDs at 700mA	LD34-700

LED colour options

Extra Warm White (2700K)	/LW27
Warm White (3000K)	/LW30
White (4000K) - on request	/LW40
Cool White (5000K)	/LW50

Other colour temperatures are available, contact sales for more information

LED spacing

50mm	/50
75mm	/75
100mm	/100

Beam / lens angle options

12° narrow spot	/NB
31° medium	/MB
48° wide	/WB
36° x 12° oval beam	/OB
60° x 15° extra oval beam	/EOB

Product colour

Silver - End caps and extrusion (silver anodised)
 Gunmetal Grey - End caps and extrusion (gunmetal grey anodised)

Fixing options

Concrete housing	/CH
Spring clips	/SC

Accessory

Frosted Diffusion Film	/FD
Glare shield (40%)	/GS40
Glare shield (50%)	/GS50
Anti glare louvre	/GL

Use with 350mA, 500mA and 700mA constant current LED drivers

We have a wide range of dimmable LED drivers, 0-10V, DMX, DALI and Mains dimmable.
 Please see the downloads section on our website

Colour LED Options - Colour Linear Light Engine 

Example: LD34-700 / LR / 50 / OB / Silver / AWB-50 / GL / 500mm

LED colour options	Suffix
Red	/LR
Green	/LB
Blue	/LG
Amber	/LA

Driver requirements and beam angles are identical to single colour light engine.